

# COBY®

## Operating Instructions

TFDVD5010



1-20-1984

# Safety Precautions



The lightning flash with an arrowhead symbol within an equilateral triangle is intended to alert the user of the presence of uninsulated "dangerous voltage" within the product's enclosure that may be of sufficient magnitude to constitute a risk of electric shock to persons.



The exclamation point within an equilateral triangle is intended to alert the user of the presence of important operating and maintenance (servicing) instructions in the literature accompanying the appliance.

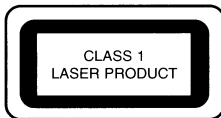

THIS DEVICE COMPLIES WITH PART 15 OF THE FCC RULES. OPERATION IS SUBJECT TO THE FOLLOWING TWO CONDITIONS: (1) THIS DEVICE MAY NOT CAUSE HARMFUL INTERFERENCE, AND (2) THIS DEVICE MUST ACCEPT ANY INTERFERENCE RECEIVED, INCLUDING INTERFERENCE THAT MAY CAUSE UNDESIRABLE OPERATION.

**WARNING: DO NOT EXPOSE THIS APPLIANCE TO RAIN OR MOISTURE, DUE TO THE HIGH RISK OF FIRE OR ELECTRIC SHOCK, DO NOT OPEN THE CABINET DANGEROUS HIGH VOLTAGES ARE PRESENT INSIDE THE ENCLOSURE. ONLY QUALIFIED SERVICE PERSONNEL SHOULD ATTEMPT THIS.**

**CAUTION: DURING PLAYBACK, THE DISC SPINS AT HIGH SPEED, SO DO NOT LIFT OR MOVE THE PLAYER, DOING SO MAY DAMAGE THE DISC.**

**CAUTION:** This Digital Video Disc Player employs a Laser System. Make sure the device is shut down prior to opening the lid, as there is visible laser radiation present. Use of controls or adjustments or performance of procedures other than those specified herein may result in hazardous radiation exposure.

## Safety Precautions

### **DO NOT STARE IN TO BEAM.**

To ensure proper use of this product, please read this owner's manual carefully and retain for future reference. Should the unit require maintenance, contact an authorized service location, or contact us. Only qualified service personnel should remove the cover.

**FCC NOTICE:** This equipment has been tested and found to comply with the limits for a Class B digital device. Pursuant with the FCC Rules, Part 15. These limits are designed to provide reasonable protection against harmful interference in a residential installation.

This equipment generates, uses and can radiate radio frequency energy and, if not installed and used in accordance with the instructions, may cause harmful interference to radio communication. However, this is no guarantee that interference will not occur in a particular installation. If this equipment does cause harmful interference to radio or television reception, which can be determined by turning the equipment off and on, the user is encouraged to try to correct the interference by one of the following measures:

- Reorient or relocate the receiving antenna.
- Increase the separation between the equipment and receiver.
- Connect the equipment into an outlet on a circuit different from that to which the receiver is connected.
- Consult the dealer or an experienced radio/TV technician for help.

**FCC Caution:** To assure continued compliance, (example-use only shielded interface cables when connecting to computer or peripheral devices). Any changes or modifications not expressly approved by the party responsible for compliance could void the user's authority to operate this equipment.

**BATTERY WARNING:** The DVD player contains a NiMH battery pack. There is a risk of fire and burns if the battery pack is handled improperly. Do not disassemble, crush, puncture, short external contacts, or dispose of in fire or water. Do not attempt to open or service the battery pack. Replace only with the battery pack designated for this product. Discard used batteries according to the manufacturer's instructions.

## Safety Information

**CAUTION: Use of controls or adjustments or performance of procedures other than those specified herein may result in hazardous radiation exposure.**

Please carefully study this manual and always keep it available. There are, however, some installation and operation precautions which you should be aware of.

1. **Read Instructions** - All the safety and operating instructions should be read before the product is operated.
2. **Retain Instructions** - The safety and operating instructions should be retained for future reference.
3. **Heed Warnings** - All warnings on the product and in the operating instructions should be adhered to.
4. **Follow Instructions** - All operating and use instructions should be followed.
5. **Cleaning** - Unplug this product from the wall outlet before cleaning. Do not use liquid cleaners or aerosol cleaners. Use a damp cloth for cleaning.
6. **Attachments** - Do not use attachments not recommended by the product manufacturer as they may cause hazards.
7. **Water and Moisture** - Do not use this product near water - for example, near a bath tub, wash bowl, kitchen sink, or laundry tub; in a wet basement; or near a swimming pool; and the like.
8. **Accessories** - Do not place this product on an unstable cart, stand, tripod, bracket, or table. The product may fall, causing serious injury to a child or adult, and serious damage to the product. Use only with a cart, stand, tripod, bracket, or table recommended by the manufacturer, or sold with the product. Any mounting of the product should follow the manufacturer's instructions, and should use a mounting accessory recommended by the manufacturer.
9. **A product and cart combination should be moved with care.** Quick stops, excessive force, and uneven surfaces may cause the product and cart combination to overturn.

## Safety Information

**10.Ventilation** - Slots and openings in the cabinet are provided for ventilation and to ensure reliable operation of the product and to protect it from overheating, and these openings must not be blocked or covered. The openings should never be blocked by placing the product on a bed, sofa, rug, or other similar surface. This product should not be placed in a built-in installation such as a bookcase or rack unless proper ventilation is provided or the manufacturer's instructions have been adhered to.

**11.Power Sources** - This product should be operated only from the type of power source indicated on the marking label. If you are not sure of the type of power supply to your home, consult your product dealer or local power company. For products intended to operate from battery power, or other sources, refer to the operating instructions.

**12.Grounding or Polarization** - This product may be equipped with a polarized alternating-current line plug (a plug having one blade wider than the other). This plug will fit into the power outlet only one way. This is a safety feature. If you are unable to insert the plug fully into the outlet, try reversing the plug. If the plug should still fail to fit, contact your electrician to replace your obsolete outlet. Do not defeat the safety purpose of the polarized plug.  
**Alternate Warnings** - This product is equipped with a three-wire grounding-type plug, a plug having a third (grounding) pin. This plug will only fit into a grounding-type power outlet. This is a safety feature. If you are unable to insert the plug into the outlet, contact your electrician to replace your obsolete outlet. Do not defeat the safety purpose of the grounding-type plug.

**13.Power-Cord Protection** - Power-supply cords should be routed so that they are not likely to be walked on or pinched by items placed upon or against them, paying particular attention to cords at plugs, convenience receptacles, and the point where they exit from the product.

**14.Protective Attachment Plug** - The product is equipped with an

## Safety Information

attachment plug having overload protection. This is a safety feature. See Instruction Manual for replacement or resetting of protective device. If replacement of the plug is required, be sure the service technician has used a replacement plug specified by the manufacturer that has the same overload protection as the original plug.

**15. Outdoor Antenna Grounding** - If an outside antenna or cable system is connected to the product, be sure the antenna or cable system is grounded so as to provide some protection against voltage surges and built-up static charges. Article 810 of the National Electrical Code, ANSI/NFPA 70, provides information with regard to proper grounding of the mast and supporting structure, grounding of the lead-in wire to an antenna discharge unit, size or grounding conductors, location of antenna-discharge unit, connection to grounding electrodes, and requirements for the grounding electrode.

**16. Lightning** - For added protection for this product during a lightning storm, or when it is left unattended and unused for long periods of time, unplug it from the wall outlet and disconnect the antenna or cable system. This will prevent damage to the product due to lightning and power-line surges.

**17. Power Lines** - An outside antenna system should not be located in the vicinity of overhead power lines or other electric light or power circuits, or where it can fall into such power lines or circuits. When installing an outside antenna system, extreme care should be taken to keep from touching such power lines or circuits as contact with them might be fatal.

**18. Overloading** - Do not overload wall outlets, extension cords, or integral convenience receptacles as this can result in a risk of fire or electric shock.

**19. Object and Liquid Entry** - Never push objects of any kind into this product through openings as they may touch dangerous voltage points or short-out parts that could result in a fire or electric shock. Never spill liquid of any kind on the product.

## Safety Information

**20. Servicing** - Do not attempt to service this product yourself as opening or removing covers may expose you to dangerous voltage or other hazards. Refer all servicing to qualified service personnel.

**21. Damage Requiring Service** - Unplug this product from the wall outlet and refer servicing to qualified service personnel under the following conditions:

- a. When the power-supply cord or plug is damaged.
- b. If liquid has been spilled, or objects have fallen into the product.
- c. If the product has been exposed to rain or water.
- d. If the product does not operate normally by following the operating instructions. Adjust only those controls that are covered by the operating instructions as an improper adjustment of other controls may result in damage and will often require extensive work by a qualified technician to restore the product to its normal operation.
- e. If the product has been dropped or damaged in any way, and
- f. When the product exhibits a distinct change in performance - this indicates a need for service.

**22. Replacement Parts** - When replacement parts are required, be sure the service technician has used replacement parts specified by the manufacturer or have the same characteristics as the original part. Unauthorized substitutions may result in fire, electric shock, or other hazards.

**23. Safety Check** - Upon completion of any service or repairs to this product, ask the service technician to perform safety checks to determine that the product is in proper operating condition.

**24. Wall or Ceiling Mounting** - The product should be mounted to a wall or ceiling only as recommended by the manufacturer.

**25. Heat** - The product should be situated away from heat sources such as radiators, heat registers, stoves or other products (including amplifiers) that produce heat.

**26. Rechargeable battery** - Charge voltage cannot be below 12V.



## Introduction

---

This product incorporates copyright protection technology that is protected by method claims of certain U.S. patents and other intellectual property rights owned by Macrovision Corporation and other rights owners. Use of this copyright protection technology must be authorized by Macrovision Corporation, and is intended for home and other limited viewing uses only unless otherwise authorized by Macrovision Corporation. Reverse engineering or disassembly is prohibited.

It is forbidden by law to copy, broadcast, show, play in public, and rent copyrighted material without permission.

DVD video discs are copy protected, and any recordings made from these discs will be distorted.

Manufactured under license from Dolby Laboratories. "Dolby" and the double-D symbol are trademarks of Dolby Laboratories. Confidential  
©unpublished works.  
1992-1997 Dolby Laboratories, Inc. All rights reserved.

"DTS" and "DTS Digital Out" are trademarks of Digital Theater Systems, Inc.

## Introduction

---

Your new portable DVD player is designed for you to enjoy all forms of disc media. Its slim shape allows you to easily carry it with you and enjoy movies and music anywhere. Your player incorporates the latest digital audio/video (AV) technologies to give you the ultimate in listening and viewing pleasure.



Your new player also supports CD and MP3. Your player also has several unique features, including an S-video output (for greater picture clarity), large active LCD screen, multi-angle and multi-language, Parental Control (to prevent children from viewing inappropriate content), and JPEG compatibility (so you can show photos on your TV). This is a truly multimedia machine designed for the multimedia world to enjoy.

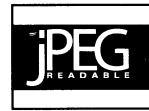

# Introduction

## UNPACKING

First inventory the contents of your Portable DVD player package:

Portable DVD Player	1
A/V Cable	1 pair
Ni-MH Battery Pack	1
Remote Control	1
External Power Adapter	1
Power Cord	1
Cigarette Lighter Adapter	1
Operating Manual	1
Stereo Earphone	1

**If any item should be damaged or missing, please contact your dealer without delay.**

**Keep the packaging materials, you may need them to transport your player in the future.**

**WARNING:** Changes or modifications made to this equipment, not expressly approved by us or parties authorized by us will void all manufacture warranties.

# Table of Contents

Safety Precautions .....	1-2
Safety Information .....	3-6
Introduction .....	7-9
Table of Contents .....	10
Quick Starting Guide .....	11-12
Connecting to a TV .....	13-14
Connecting to Optional Equipment .....	15-17
Playing Back a Disc .....	18-21
JPEG Playback .....	22-23
MP3 Playback .....	24
Locating a Specific Title, Chapter or Track .....	25
Playing Repeatedly .....	26-27
Playing in Favorite Order .....	28-29
Zooming a Picture .....	30
Selecting Subtitles .....	31
Using the On-Screen Display .....	32
Selecting the Camera Angle .....	33
Setting the Parental Lock .....	34-35
Rechargeable Battery Installation & Use .....	36-37
Battery Storage .....	38
Customizing the Function Settings .....	39-40
Trouble Shooting Guide .....	41

## Quick Starting Guide

### 1. Connect with the AC/DC adapter and slide the batch to 'ON' as follows

If you want to power the unit with battery, details refer to page 38. Do not use any other device otherwise specified by your dealer.

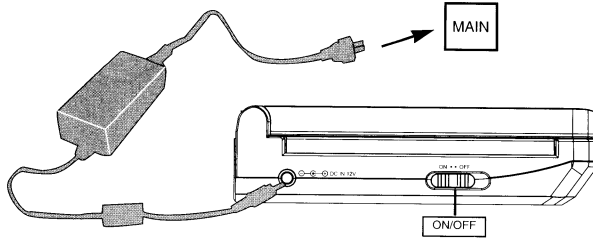

### 2. Open the protective cover

The cover opens to a maximum 135° only, so please do not try to open it any further.

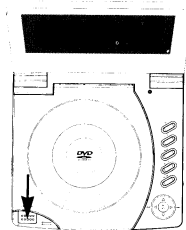

### 3. Press the open button on the left to open the disc cover

### 4. Inserting a DVD disc

Align the center of the DVD disc with the center of the disc guide. Press gently down on the DVD to snap the disc into place, then close the disc cover.

## Quick Starting Guide

### 6. Press the **PLAY** button on the player face

In general, if the DVD is already inserted into the player, it will start reading the disc automatically when the power is turned on .

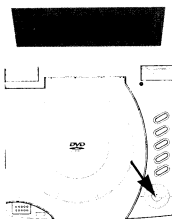

### **The DVD player will immediately start rendering the DVD program.**

When you want to stop, press the **STOP** button, it will return to the power-on logo. To power off the unit, slide the **ON/OFF** switch to the right.

 The DVD player will automatically power off in three minutes after entering screen saver mode. To reset the unit, first slide power switch to 'OFF', and then slide it to 'ON'.

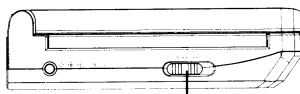

ON/OFF

## Connecting to a TV

### SETTING UP YOUR PLAYER

Step 1. Connect the Red & White Audio cables to the AUDIO OUT of the DVD player.

Step 2. Connect the Yellow Video cable to the Video on the side of the player.

(For TVs that support S-Video Output please follow the "BETTER" diagram.)

### GOOD

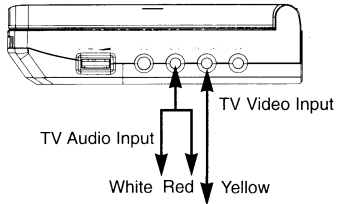

## Connecting to a TV

**BETTER**

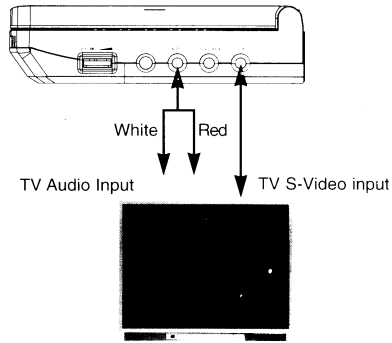

*Connect the portable DVD player with an optional S-Video cable, if the TV has an S-Video input. Do not connect the yellow video cable if using the S-Video cable.*



- Turn off the power and unplug both units before setting up any connections.



## Connecting to Optional Equipment

### CONNECTING HEADPHONES

**1. Connect the headphones.**

Headphones with a 3.5 mm stereo plug can be connected.

**2. Adjust the volume by turning the dial.**

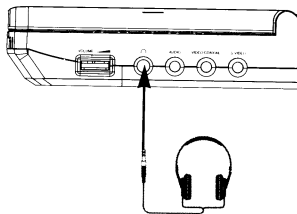

- Avoid listening to sound at levels which may be harmful to your ears.

# Connecting to Optional Equipment

## Enjoying Dolby Pro Logic Surround Sound (GOOD) Dolby Pro Logic Surround

Enjoy the dynamic realistic sound of Dolby Pro Logic Surround by connecting an amplifier and speaker system (right and left front speakers, a center speaker, and one or two rear speakers).

Connection  
Example

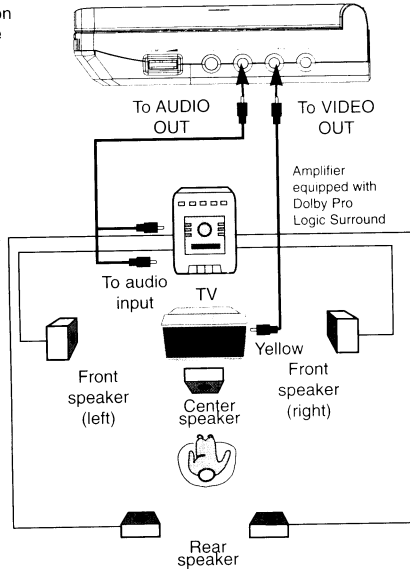

## Connecting to Optional Equipment

### Enjoy Dolby Digital or DTS (BETTER) Dolby Digital/DTS

Dolby Digital and DTS programming can deliver surround sound with five discrete full range channels plus a sixth channel for a subwoofer. You can enjoy your DVD with a Dolby Digital System. All you need is to connect your DVD player to a Dolby Digital/DTS receiver or a Dolby Digital Ready receiver with an external decoder.

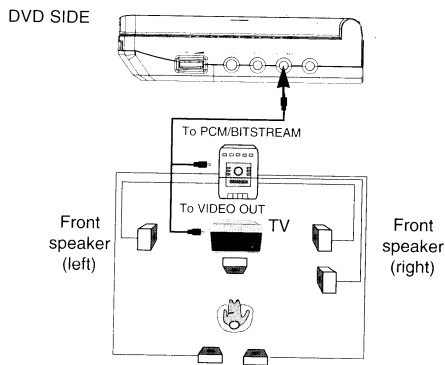

Set "SPDIF Output" to "SPDIF/PCM" in "General Setup" from the Setup Menu.

# Playing Back a Disc

## CONTROLS FOR BASIC PLAYBACK

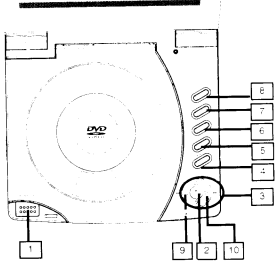

1. Open/Push
2. Play/Enter
3. Direction keys
4. Menu
5. Set up
6. Pause
7. Stop
8. LCD adjust
9. Previous
10. Next

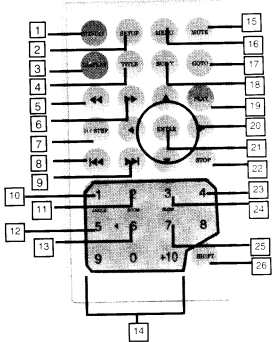

- |                |                          |
|----------------|--------------------------|
| 1. STANDBY     | 15. MUTE                 |
| 2. SETUP       | 16. MENU                 |
| 3. DISPLAY     | 17. GOTO                 |
| 4. TITLE       | 18. SUBTITLE             |
| 5. REVERSE     | 19. PLAY                 |
| 6. FORWARD     | 20. DIRECTION            |
| 7. PAUSE/STEP  | (UP/DOWN/<br>RIGHT/LEFT) |
| 8. PREVIOUS    |                          |
| 9. NEXT        | 21. ENTER                |
| 10. REPEAT     | 22. STOP                 |
| 11. A-B REPEAT | 23. AUDIO                |
| 12. ANGLE      | 24. PROGRAM              |
| 13. ZOOM       | 25. SLOW                 |
| 14. NUMBERS    | 26. SHIFT                |

**Note:**

When you need to use the keys REPEAT, A-B, PRGM, AUDIO which are combined with numbers, set shift on by pressing SHIFT, and set shift off to use NUMBERS by pressing SHIFT again.

# Playing Back a Disc

## HOW TO START PLAYBACK FROM THE MENU SCREEN

1. Press **TITLE/MENU** to access the menu screen.

2. Press **^/V/</>** or the number buttons to select the title.

3. Press the **ENTER** or **PLAY** button.

The DVD video player will start playback from the title selected.

**Note:**

You also can input the assigned number of the title to select it directly.

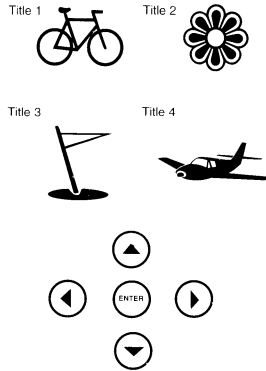

## HOW TO PAUSE PLAYBACK (STILL PLAYBACK)

Press the **PAUSE/STEP** once during playback.

Press **PAUSE/STEP** repeatedly during playback, the picture will advance one frame each time, then press **PLAY** to resume normal playback.

During the still playback the sound is muted. MP3 CD and Audio CD do not have the step feature.

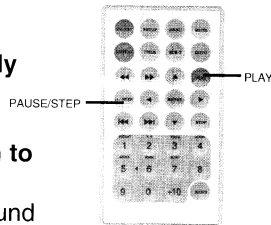

# Playing Back a Disc

## HOW TO STOP PLAYBACK

**Press the STOP button.**  
The player is stopped.

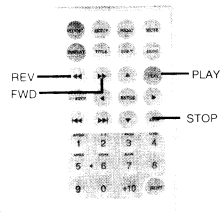

## FAST FORWARD & REWIND

You can playback a disc at 2x, 4x, 8x, 16x or 32x the normal speed for fast forward or rewind.

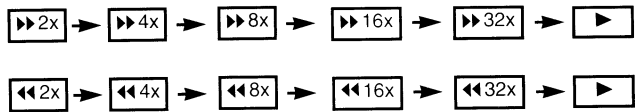

**Press the REV or FWD button during playback.**  
The playback speed becomes double the normal speed.  
The playback speed changes, each time you press the REV or FWD button.

**TO RESUME NORMAL PLAYBACK.**  
Press PLAY.



**Note:**  
The function is invalid on some DVD discs.

# Playing Back a Disc

## PLAYING IN SLOW-MOTION

A disc can also be played back in slow-motion.

**1. Press SHIFT to set shift on so as to use the SLOW button.**

TV SCREEN

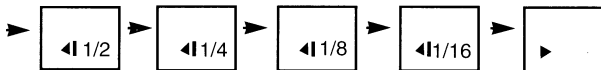
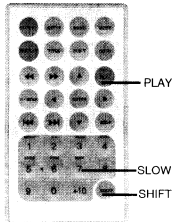
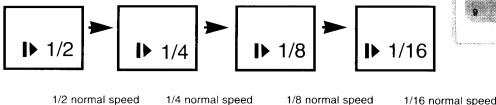

**2. Press the SLOW button during playback**

The playback speed becomes  $1/2$ ,  $1/4$ ,  $1/8$ , or  $1/16$  of the normal speed each time you press the SLOW button.

**TO RESUME NORMAL PLAYBACK.**  
**Press PLAY.**





- During REV, FWD and slow-motion playback, the sound is muted.
- The function is invalid on some DVD discs.

## JPEG Playback

YOU CAN USE YOUR DVD PLAYER TO VIEW PICTURES SAVED ON A CD-R. THE PHOTOGRAPHS ON THE DISC NEED TO BE SAVED IN THE JPEG FILE FORMAT. FOR MORE INFORMATION ABOUT JPEGS PLEASE VISIT [WWW.JPEG.COM](http://WWW.JPEG.COM).

### PLAYING BACK JPEG FILES

**1. Place the CD on the disc tray.**

**2. Select a folder or a picture contained on the CD.**  
After the CD is loaded, a menu will appear on the screen.

Press UP or DOWN to select a folder, and press ENTER/PLAY to view folder contents (shown in right column as below).

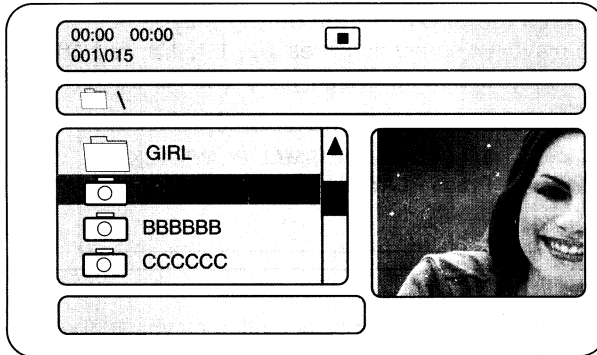



### 3. Start playback

Use UP or DOWN to select one image and press ENTER/PLAY to view the pictures.

The pictures will be displayed in a style of a slideshow, there are many styles of transition effects such as Wipe Top (default mode), Wipe Bottom, Wipe Left, Wipe Right, Diagonal Wipe Left Top, Diagonal Wipe Right Top, Extend from Centre H, Compress to Centre H, Window H, etc., use the **GOTO** button to change the slide style.

### 4. Rotate an image

During the slide show, you can use arrow keys to rotate an image:

Press UP to invert an image.

Press DOWN to mirror an image.

Press LEFT to rotate an image to the left.

Press RIGHT to rotate an image to the right.

### 5. Zoom

This feature allows you to view a picture at 50%, 75%, 125%, 150% or 200% in several increments. Press the **ZOOM** button. An on screen message ("**Zoom On**") will verify your selection. Use ►► and ◀◀ keys to control the amount of zoom in and out. Press the direction keys to shift the zoom point. With **Zoom Off**, the picture is scaled to fit most of your TV screen.

### 6. Menu

During the playback, press MENU to access thumbnail menu. For previewing JPEG files, press MENU again to return to JPEG folders.

## CREATING YOUR OWN PHOTO DISKS

Using your computer save pictures as JPEG format and burn them on a CD-R disc, then you can watch on your TV.

# MP3 Playback

## PLAYING AN MP3 FORMAT

1. Insert an MP3 CD, the DVD player will initialize the disc when the tray is closed and the directory (folder) will be shown in an MP3 MENU on screen.
2. Press UP/DOWN to select and highlight an MP3 file (song).
3. Press ENTER to play the MP3 file.

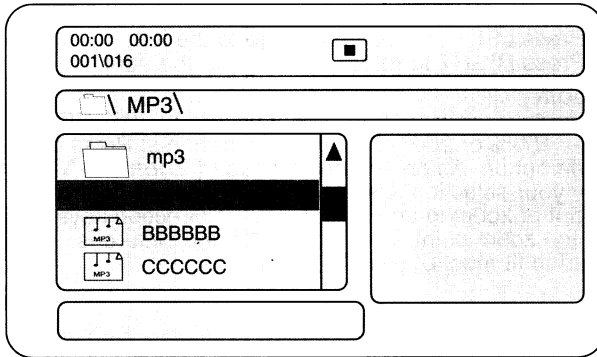

## Locating a Specific Title, Chapter or Track

DVD DISCS ARE NORMALLY DIVIDED INTO TITLES WHICH ARE SUB-DIVIDED INTO CHAPTERS. MOREOVER, CD AND MP3 CD ARE DIVIDED INTO TRACKS.

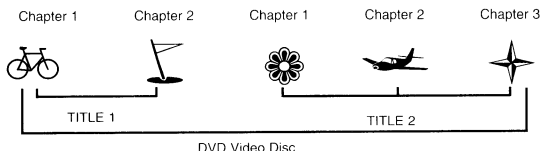

### LOCATING A TITLE USING THE TITLE MENU

You can locate a specific title using the title menu function, if a DVD video disc contains a title menu.

#### 1. Press the **TITLE** button

On the LCD or TV screen, the title menu will appear.

#### 2. Press the **▲▼◀▶** button to select the title you want.

You can also directly locate a specific title by pressing its assigned number with the number buttons.

#### 3. Press the **PLAY** button

This will cause the DVD video player to start playback from chapter 1 of the title selected.

**You also can use skip buttons to select a title or track desired:**

**Press ◀◀ or ▶▶ button repeatedly till the one displays.**

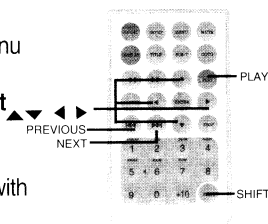

## Playing Repeatedly

THIS DVD VIDEO PLAYER ALLOWS YOU TO PLAYBACK A SPECIFIC TITLE, CHAPTER, TRACK, OR SEGMENT REPEATEDLY. (TITLE REPEAT, CHAPTER/TRACK REPEAT, A-B REPEAT)

### HOW TO REPEAT A TITLE, CHAPTER, OR DISC

During normal playback, press the REPEAT button (set shift on).

The repeat mode changes, each time you press the REPEAT button.

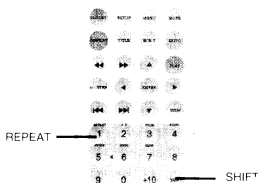
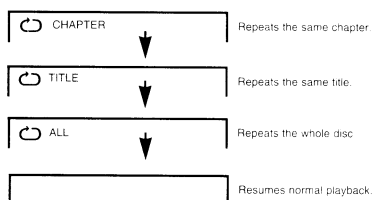

## Playing Repeatedly

### HOW TO REPEAT A SPECIFIC SEGMENT

1. Press the A-B button at the beginning of the segment in which you want to repeat playback (point A) (set shift on).

2. Press the A-B button again at the end of the segment (point B)

The DVD video player will automatically return to point A and start to repeat playback of the selected segment (A-B).

3. Press the A-B button to cancel the A-B repeat function

The DVD video player will resume to normal playback.

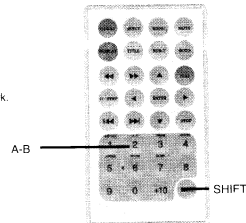
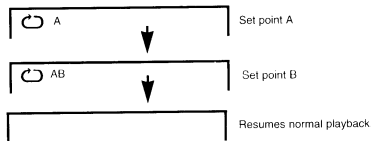

## Playing in Favorite Order

### HOW TO SET TITLES, CHAPTERS, OR TRACKS IN A FAVORITE ORDER

**1. Press the PROGRAM button.**

PROGRAM MENU displays on the screen.

PROGRAM:TT(01)/CH ( - - )			
01	TT: CH:	06	TT: CH:
02	TT: CH:	07	TT: CH:
03	TT: CH:	08	TT: CH:
04	TT: CH:	09	TT: CH:
05	TT: CH:	10	TT: CH:
EXIT		NEXT ▶▶	

**2. Using the numbered button, select the items you want in the order you want them programmed in.**

The number of the item selected will be input into the PROGRAM volume.

PROGRAM:TT(01)/CH ( - - )			
01	TT: 03 CH: 01	06	TT: CH:
02	TT: CH:	07	TT: CH:
03	TT: CH:	08	TT: CH:
04	TT: CH:	09	TT: CH:
05	TT: CH:	10	TT: CH:
EXIT		START	NEXT ▶▶

## Playing in Favorite Order

- 3. Highlight **START** and press **ENTER** to start program playback.
- 4. To clear the programming, move the cursor to **STOP** and then press **ENTER** to confirm.

PROGRAM:TT(01)/CH ( - - )			
01	TT: 03 CH: 01	06	TT: CH:
02	TT: CH:	07	TT: CH:
03	TT: CH:	08	TT: CH:
04	TT: CH:	09	TT: CH:
05	TT: CH:	10	TT: CH:
EXIT    STOP    NEXT 			

# Zooming a Picture

## ZOOMING A PICTURE

This DVD video player allows you to zoom into a picture as well as shift the zoom point.

Press **ZOOM** during normal playback or slow - motion. (To use the **ZOOM** button, it should be set 'SHIFT ON' by pressing **SHIFT**.)

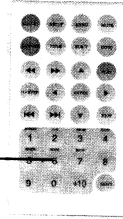

The player magnifies in the center of the picture. If you press **▲ ▼ ◀ ▶** during zoom playback, the zoom point shifts.

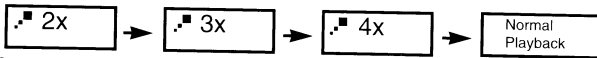
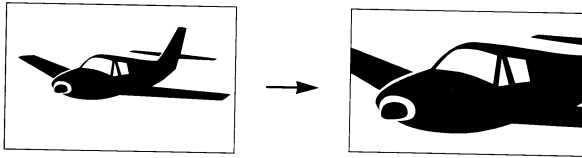

To cancel the zoom function, press **ZOOM** again.



# Selecting Subtitles

## HOW TO DISPLAY SUBTITLES

You have the option to select a preferred subtitle from those included on the DVD video disc.

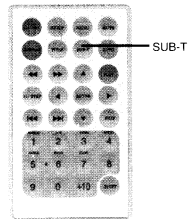
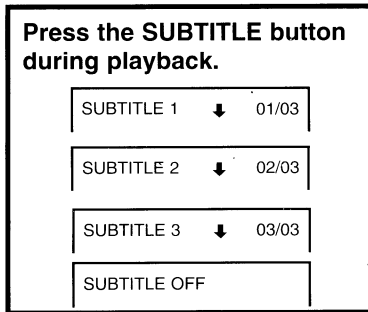

To **TURN OFF** the subtitles.

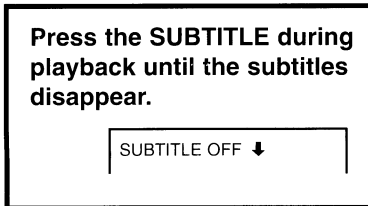

# Using the On-Screen Display

THIS UNIT ALLOWS YOU TO VIEW THE OPERATIONAL STATUS AND DISC INFORMATION ON YOUR TV SCREEN.

## CHECKING THE OPERATIONAL STATUS

With this function you can view on your TV the following:

- Current title
- Track number
- Total playing time

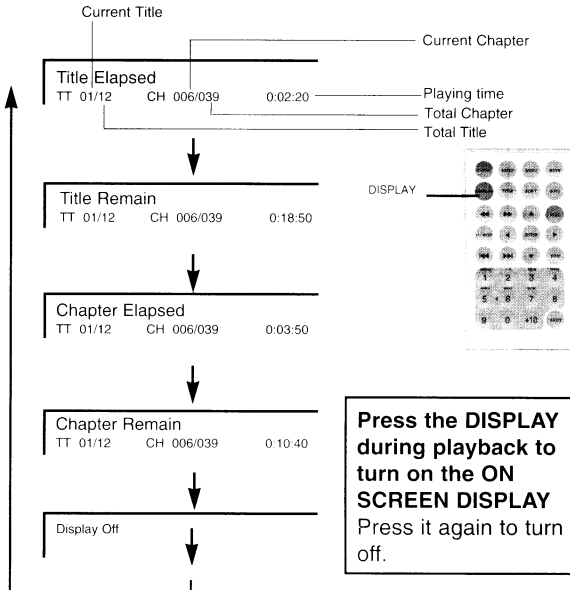

## Selecting the Camera Angle

THIS DVD VIDEO PLAYER ALLOWS YOU TO SELECT FROM SEVERAL DIFFERENT ANGLES.

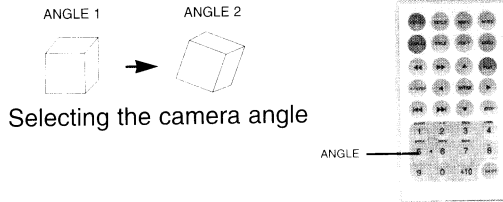

## HOW TO CHANGE THE CAMERA ANGLE

If the DVD video disc was recorded with multiple angles, you have the option to change the camera angle of the scene you are watching.

**Press the ANGLE button while playing back a scene recorded with multiple angles (set shift on).**

- You may only press the ANGLE button when the angle icon  is flashing on the DVD display.
- Press the corresponding number of your desired angle.

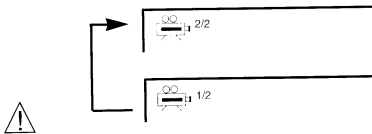

- The angle function will not work on DVD video disks that do not contain multiple angles.

# Setting the Parental Lock

YOU CAN USE THE PARENTAL LOCK FUNCTION ONLY WITH DVD VIDEO DISCS EQUIPPED WITH THE PARENTAL LOCK FEATURE.

## SETTING THE PARENTAL LOCK

DVD video discs equipped with the parental lock function are rated according to their content. The content allowed by a parental lock level and the way a DVD video disc can be controlled, vary from disc to disc. For example, if the disc allows, you can edit out violent scenes unsuitable for children and replace them with more suitable scenes, or lock out playback of the disc completely.

**1. Press STOP during playback**

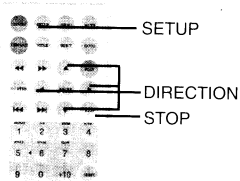

**2. Press SETUP**

The SETUP MENU appears on the screen.

**3. Select Preference Page, press ENTER.**

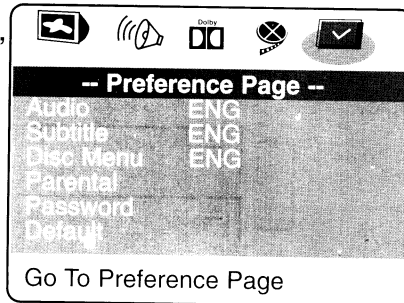

# Setting the Parental Lock

4. Select Parental, press ENTER.

5. Select ratings, press ENTER

- 1 KID SAFE
- 2 G
- 3 PG
- 4 PG 13
- 5 PGR
- 6 R
- 7 NC17
- 8 ADULT
- OFF

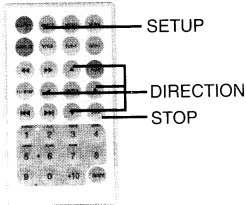

6. Enter your password then press ENTER.

The pre-set password is **3308**

7. Press **SETUP** to exit setup, press **ENTER** to start.

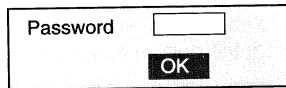

## TO CHANGE YOUR PASSWORD:

1. Follow step 4 to select password change.
2. Enter old password.
3. Enter new password.
4. Re-enter to confirm your new password.
5. Press **ENTER**.
6. Press **SETUP** to exit.

### WARNING:

Please keep a copy of the new pass code in a safe place, otherwise you will not be able to change the Parental Control.

Please remember your **PASSWORD**, as the **DEFAULT** setting will revert everything **BUT** the **PASSWORD** to the factory defaults.

# Rechargeable Battery Installation & Use

## INSTALLING & REMOVING THE BATTERY PACK

1. Make sure the unit is powered off and unplugged.
2. Attach the battery pack to the outlet of the unit as the arrowhead 1, and push it forward as arrowhead 2 to align them with each other till you hear a click sound.

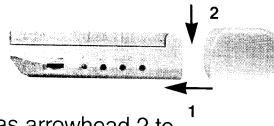

### Removing the Battery Pack

1. Make sure the unit is powered off and unplugged.
2. Pull the battery pack backward as arrowhead 3 while sliding the latch as 4 (at the bottom of the unit).

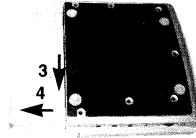

## USE AND MAINTENANCE

THIS UNIT IS SUPPLIED WITH HIGHLY-EFFECTIVE RECHARGEABLE BATTERY (NI-MH). SUCH BATTERY PACK A HIGH STORAGE CAPACITY AND LOW LEVEL OF DEGRADATION. THE LATTER MEANS THAT THE BATTERY CAN ALSO BE RECHARGED WHEN ONLY PARTLY SPENT.

**Plug the AC adapter into the battery.**  
**Please fully charge the battery prior to first use.**

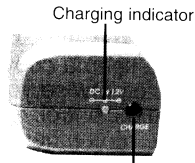

AC Adapter/charge input

## Rechargeable Battery Installation & Use

The provided battery can be recharged approximately 300 times. It takes about 4-5 hours to recharge the battery. The red indicator will go out and the green indicator will flash. A fully charged battery can power the unit for about 2.5 hours. Power consumption depends on the operations of the player such as brightness of the screen, volume level, etc.

**Recharge the battery when fully spent in order to maximize its life.**

**Never recharge a fully charged battery.**

Under no circumstance should you short out the battery, store it in a metal container, or leave it in a humid or damp environment. Store the battery in an airtight container if possible. Recharge effectiveness will degrade when environmental temperatures drop below 10 °C or exceed 35 °C.

# Battery Storage

---

## 1. Storage Temperature and Humidity (Short-term)

In a dry location with low humidity (Max.85%), no corrosive gases, at a temperature range of -20°C to 45°C.

In a location where humidity is extremely high or with temperature below -20°C or above 45°C, the metallic parts of battery will rust and result in electrolyte leakage due to expansion or contraction in parts composed of organic materials.

## 2. Long-term Storage (2 years, -20°C to 35°C)

As long-term storage can accelerate battery self-discharge and lead to the deactivation of reactants, locations where the temperature ranges between 10°C and 30°C are suitable for long-term storage.

When charge for the first time after long-term storage, deactivation of reactants may have led to increased battery voltage and decreased battery capacity. Restore such batteries to original performance through repeating several cycles of charge and discharge.

When storing battery for more than 1 year, charge at least once a year to prevent leakage and deterioration in performance due to self-discharge. When using a rapid charger of voltage detection type, carry out charge and discharge at least once every 6 months.

### Note:

To get the best performance, charge your battery for more than 12 hours at the first time after unpacking, and carry out 3 cycles of charge and discharge under proper conditions.



## Customizing the Function Settings

THIS UNIT ALLOWS YOU TO CUSTOMIZE THE PERFORMANCE TO YOUR PERSONAL PREFERENCE.

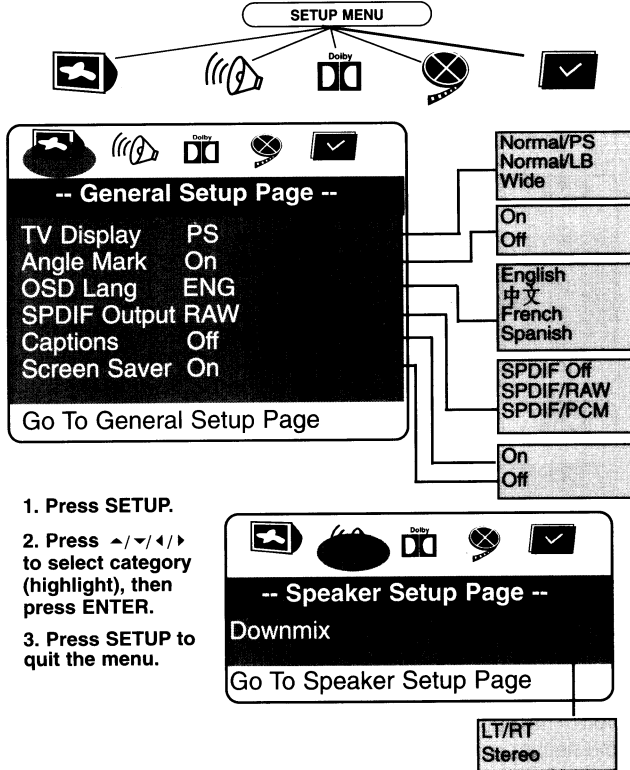

1. Press **SETUP**.
2. Press **▲/▼/◀/▶** to select category (highlight), then press **ENTER**.
3. Press **SETUP** to quit the menu.

# Customizing the Function Settings

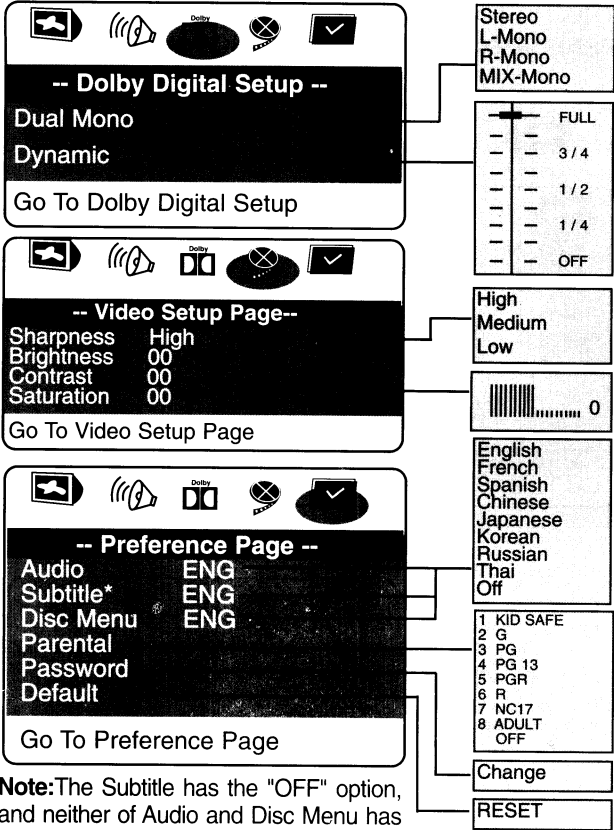

**Note:**The Subtitle has the "OFF" option, and neither of Audio and Disc Menu has it.

## Trouble Shooting Guide

Symptom	Correction
No power	<ul style="list-style-type: none"><li>• Connect the power plug into the power port securely.</li></ul>
No picture/sound	<ul style="list-style-type: none"><li>• If playing back through a TV, verify the connection of the video and audio cables.</li></ul>
Distorted picture	<ul style="list-style-type: none"><li>• Make sure it is right in NTSC/PAL, the button is on the rear panel of the unit.</li></ul>
Black & White picture	<ul style="list-style-type: none"><li>• Damaged S connector (Bent pin).</li></ul>
The player does not start playback	<ul style="list-style-type: none"><li>• Insert a playable disc. (Check the disc type and color system).</li><li>• Place the disc with the playback side down and correctly inside the guide.</li><li>• Clean the disc.</li><li>• Cancel the parental lock function or change the parental lock level. (<i>The Pre-set password is 3308.</i>)</li><li>• Reset the portable DVD player.</li></ul>





0016ss/1/M